

SLCD 403

MANUAL PARA EL USUARIO

VESA: 75 x 75/ 100 x 100/ 200 x 200
 Para LCD/ LED/ PLASMA de 15" a 42"

Debido a que algunos televisores de 42" tienen un VESA mayores a 200 x 200, este soporte no es compatible con el 100% de los televisores de ese tamaño.

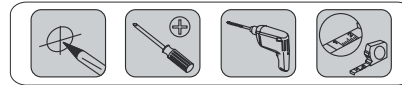
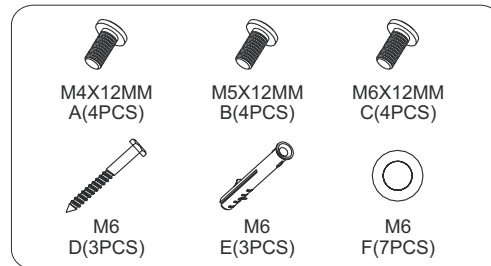
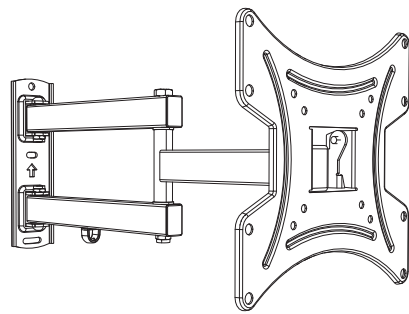

PASO 1 Montaje a pared

Pared de concreto

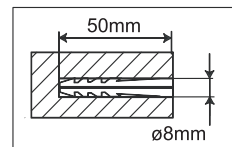
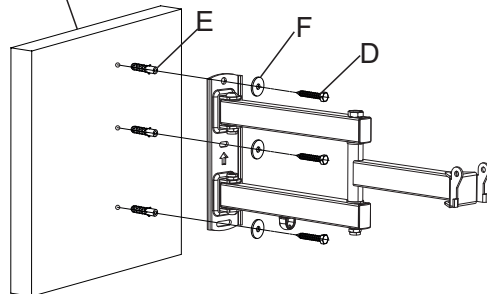

PASO 2 Montaje sobre placa de madera

Placa de madera

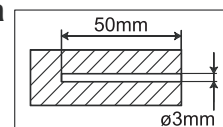
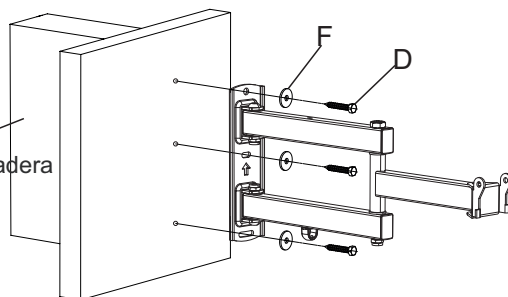

PASO 3 Ajuste los brazos a la pantalla

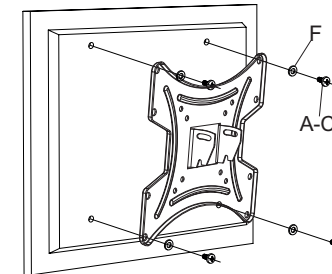

PASO 4 Encastre la TV al soporte de pared

